



## TENMARS TM-402A Air Velocity Meter User Manual

[Home](#) » [TENMARS](#) » TENMARS TM-402A Air Velocity Meter User Manual

TENMARS TM-402A Air Velocity Meter User Manual



## Contents [ [hide](#) ]

- [1 Introduction](#)
- [2 CHARACTERISTICS](#)
- [3 Functions Cross table](#)
- [4 Air Velocity Meter Features](#)
- [5 Display Features](#)
- [6 Power On/Off](#)
- [7 Change Secondary Display Mode](#)
- [8 Change Units](#)
- [9 Air Flow Calculation](#)
- [10 MAX/MIN/AVG record](#)
- [11 Freeze Display \(HOLD\)](#)
- [12 99 Records](#)
- [13 Clear Memory](#)
- [14 Memory Recall](#)
- [15 Checking the LCD and Software Version](#)
- [16 Battery Replacement](#)
- [17 PRECAUTIONS](#)
- [18 Specifications](#)
- [19 End of life](#)
- [20 Documents / Resources](#)
  - [20.1 References](#)
- [21 Related Posts](#)

## Introduction

TM-4XXA series measures air speed, temperature and humidity. It is ideal for spot measurements at air outlets on account of its 30mm vane. In addition to air speed and temperature, TM-404A and TM-414A also measures air moisture and absolute pressure. In this way, air conditions can be reliably checked.

## CHARACTERISTICS

- 30mm 6 plastics blade.(TM-40XA)
- 45mm 4 plastics blade.(TM-41XA)
- Light air response 0.4m/s
- Rapid response temperature sensor
- Air flow calculate function.
- Max/Min/Avg and data hold.
- Auto power off with disable function.
- Low battery indication. “  ”
- Low battery indication.
- Data logging capacity: 99 records.
- Memory recall function.
- Backlight function.
- Absolute Pressure Sensor.
- Humidity Sensor
- DEW-POINT and WET-BULB temperature measurement.

## Functions Cross table

Functions	TM402A(With Pr401T)	TM403A(With Pr401T)	TM404A(With Pr401T)
Velocity	●	●	●
Flow	●	●	●
99 Record	●	●	●
Temperature	●	●	●
Humidity		●	●
Pressure			●

Functions	TM412A(With Vane-01 )	TM413A(With Vane-01 )	TM414A(With Vane-01)
Velocity	●	●	●
Flow	●	●	●
99 Record	●	●	●
Temperature	●	●	●
Humidity		●	●
Pressure			●

## Air Velocity Meter Features

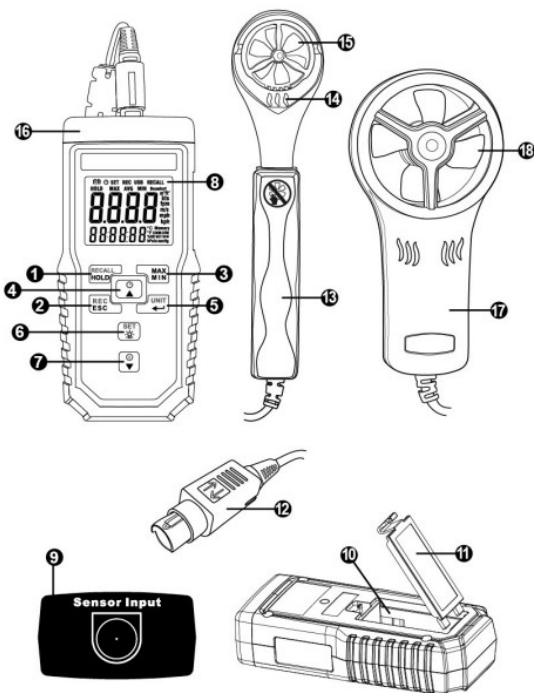

1. HOLD and Recall key
2. ESC and Rec key
3. Max, Min and AVG key

4. Select up and Auto shutoff key
5. Enter and Unit change key
6. Select down and Power key
7. Backlight and Set Key
8. Display and Backlight
9. Probes input
10. Battery placement
11. Battery cover
12. Probes Plug
13. Probes hold
14. Probes sensor (Temperature/Humidity)
15. Blades
16. Internal Pressure Sensor (TM-404A/414A)
17. Probes hold
18. Blades

## Display Features

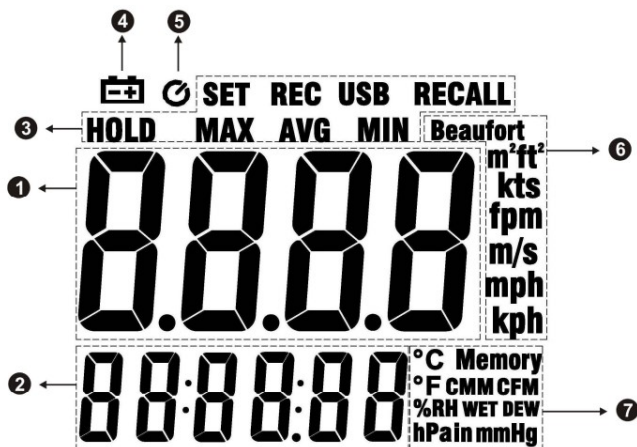

1. Primary display
2. Secondary display
3. Functional symbol display area
4. Lower battery indication.
5. Auto shutoff symbol indication.
6. Units of Primary display
7. Units of Secondary display

## Power On/Off

In the shutoff mode Press  key to turn on the power.

If want to turn off Press and hold  key.

- In the Set ,Unit change and recall mode can not turn off the power

### Auto Shutoff

The device will auto shutoff if there is no action for 15 minutes.

If want to disable or enable the auto power off function, please press and hold  key.







- In the Set ,Unit change and recall mode can not change this.

### LED Backlight

When press  key to turn on backlight. Press key to turn off again. The backlight will turn off of after 30 seconds.

### Auto Backlight On/Off

Users can set on or off the 30-seconds auto-off backlight

Press and hold  key into setting mode. Press  and  key to select BLIGHT setting, as shown in figures. Press  key into Backlight setting. Press  and  key to select auto off on or off. Press  key to finish and leave setting mode.



### Air Velocity Measures

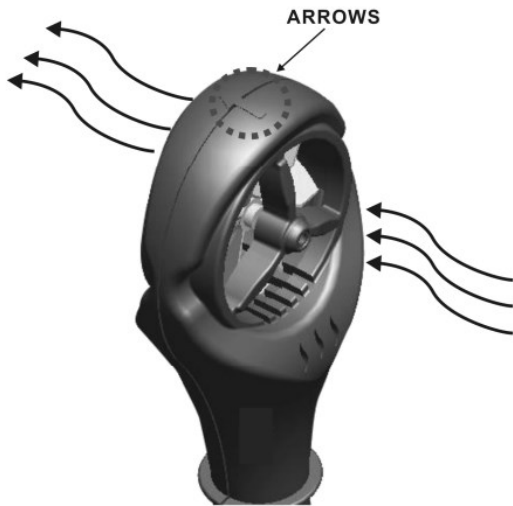

1. Please insert probe plug into the device sensor input socket.
2. Follow the arrows to measure velocity. As shown in figures.



- Please don not touch the blades by fingers or foreign body to avoid damage to the blades.







## Change Secondary Display Mode

In the normal mode, Press  and  key to change secondary display mode. The order of °C CMM(CFM) °C WET(403A/404A/413A/414A) °C DEW (403A/404A/413A/414A) hPa(404A/414A) %RH (403A/404A/413A/414A).

- In the Humidity mode need to waiting minutes to acquire accuracy humidity reading

## Change Units

Press and hold  key into the setting units mode. If want to change the secondary display units, please press and  hold key again.

When in the setting units mode, LCD blink the choose unit. Press  and  key to change the units and press  key to finish and leave



setting mode. Unit to switch the order of Beaufurt kts fpm m/s mph kph

## Air Flow Calculation



When secondary display in the flow mode (CMM/CFM), the device will calculate flow by the users key in area volume.

## Setting Area

Press and hold  key into the setting mode.

Press  and  key to select setting area mode, as shown in figures. Press  key into the setting area mode.

From left to right to set the digits, and press  and  key to adjust digits to left or right.



Press  and  key to increase and decrease volume through last right digits.

Users can press and hold  key to change area units (m<sup>2</sup> / ft<sup>2</sup> ).



- The units(m<sup>2</sup> ) maximum volume is 1.5 m<sup>2</sup> , and minimum volume is 0.096 m<sup>2</sup> .
- The units (ft<sup>2</sup> ) maximum volume is 16.15 ft<sup>2</sup> , and minimum volume is 1.03 ft<sup>2</sup> .



## MAX/MIN/AVG record

This function can record maximum, minimum and average. User can select viewing. Press  key to start record MAX, MIN, and AVG. Show the max reading to display. Press  key to switch viewing between MAX, AVG and MIN.

Press and hold  key to disable this function.

- In the Set ,Unit change and recall mode can not used this function.

## Freeze Display (HOLD)

Users can press  key to freeze display, and press  key again to release display.

- In the Set ,Unit change and recall mode can not used this function.

## 99 Records

Device cans storage air velocity data up to 99 records.



Press  key to storage once record data, and shown memory location on the LCD about 1 second.

- When the enable HOLD and MAX/MIN function, the record data still real reading.

## Clear Memory

When the memory are full or want to clear memory data, please fallow the setup to clear memory.

Press and hold  key into the setting mode, as\ shown in figures.

Press  and  key to select the clear memory mode.

Press  key into the clear memory mode.  
The LCD showed the “yes” to reconfirm.



Press  key to leave or press  key to clear memory and leave clear memory mode.



## Memory Recall

Users can recall the memory data to show on the display.

Press and  hold key into the RECALL mode.  
The secondary display showed the memory location and primary display showed the storage velocity data.

Press  and  key to increase and decrease memory location.

If want to leave the recall mode, please press and hold  key to leave this mode.



## Checking the LCD and Software Version



In the shutoff mode, Press and hold key to turn on device and LCD will keep all dark continued. Starting device will show the software version about 1 second.

## Battery Replacement



**WARNING**



If the symbol “” appears on the LCD, please replace the battery immediately

Turn off the device and disconnect all test leads before replacing the battery.  
Use only the correct type of batteries, properly installed in the case, to power the device.

## PRECAUTIONS

Removing Probe (With LOCK) :

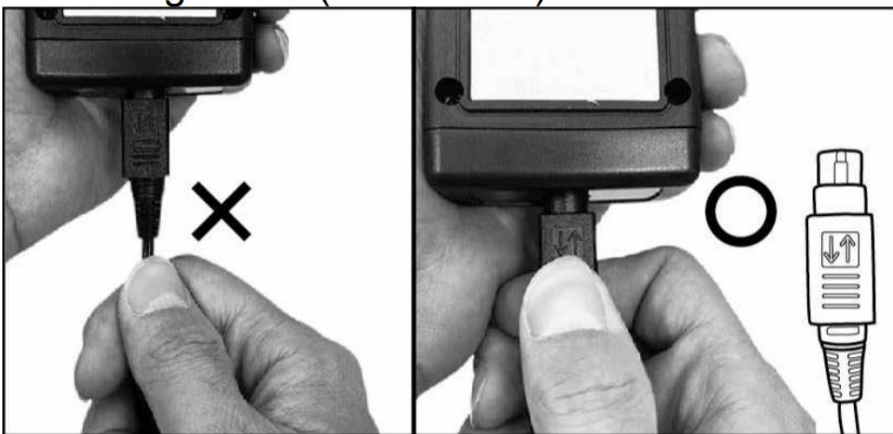

## Specifications

Velocity(TM-402A~TM-404A):

Unit	Range	Resolution	Accuracy
m/s	0.4~20	0.1	±2 +0.2
Km/hr(kph)	1.5~72	0.1	±2 +0.8
mph	0.9~44	0.1	±2 +0.4
Knots(kts)	0.8~38	0.1	±2 +0.4
ft/min(fpm)	79~4000	1	±2 +40
Beaufort	1~8	1	—

**Velocity(TM-411~TM-414):**

Unit	Range	Resolution	Accuracy
m/s	0.4~30	0.1	±3 +0.2
Km/hr(kph)	1.5~106	0.1	±3 +0.8
mph	0.9~66	0.1	±3 +0.4
Knots(kts)	0.8~58	0.1	±3 +0.4
ft/min(fpm)	79~5866	1	±3 +40
Beaufort	1~8	1	—

**Air Flow Calculation:**

Unit	Range	Resolution	Accuracy
CMM	0~9999	1	—
CFM	0~9999	1	—

**Temperature**

Unit	Range	Resolution	Accuracy
°C	-20~60	0.1	±1°C
°F	-4~140	0.1	±1.8°F

**Humidity:**

Unit	Range	Resolution	Accuracy
%RH	20~80	0.1	±3.5%RH
%RH	<20 , >80	0.1	±5%RH

**Absolute Pressure:**

Unit	Range	Resolution	Accuracy
hPa	350~1100	0.1	±2hPa
mmHg	263~825	0.1	±1.5mmHg
inHg	10.3~32	0.1	±0.1

- **Display** : 42mm(W) x33mm(L) Monochrome LCD with backlight
- **Battery** : 9V (NEDA 1604 IEC 6F22 or JIS 006P)

- **Battery Lift** : Approx continuous used 100 hours.
- **Shutoff Rate Power** : 3uA
- **Operate Maximum Power** : 25mA
- **Operating temperature and humidity** : 5°C to 40°C, below 80% RH.
- **Storage temperature and humidity** : -10°C to 60°C, below 70%.
- **Instrument dimensions** : 40(L) x 65(W) x 38(H) mm.

Weight : About 285g(TM-402A~403A).

About 240g(TM-404A).

About 296g(TM-412A~414A).

- **Probe dimensions (TM-402A~TM-404A)** : 195(L) x 47(W) x 30(H) mm. Cable length : 95cm.
- **Probe dimensions (TM-412A~TM-414A)** : 135(L) x 67(W) x 31(H) mm. Cable length : 95cm.
- **Weight** : About 100g.
- **Accessories** : User's manual x1, 9V battery x1, Probe x1, Bag x1'

## End of life



### Caution:

This symbol indicates that equipment and its accessories shall be subject to a separate collection and correct disposal

## Professional Electrical and Environment Test & Measurement Instruments:

Battery Capacity / Impedance Tester

LED light meter, Temperature & Humidity meter, Infrared Thermometer, Sound level meter

Light meter, EMF meter, UV Light meter, RF meter, Hot wire Anemometer, CO meter

Anemometer, Lan cable tester, CO2 meter, Solar power meter, Radiation meter,

Clamp meter, Multimeter, Phase Rotation test, Digital Insulation tester

**Our products of high quality are selling well all over the world**

TENMARS ELECTRONICS CO., LTD  
6F, 586, RUI GUANG ROAD, NEIHU,  
TAIPEI 114, TAIWAN.

E-mail: [service@tenmars.com](mailto:service@tenmars.com)

<http://www.tenmars.com>

## Documents / Resources

<p>TENMARS Air Velocity Meter TM-402A/403A/404A TM-412A/413A/414A User Manual</p> <p>CE H27M402A01 TENMARS ELECTRONICS CO., LTD</p>	<p><a href="#">TENMARS TM-402A Air Velocity Meter</a> [pdf] User Manual TM-402A Air Velocity Meter, TM-402A, Air Velocity Meter, Velocity Meter</p>
---------------------------------------------------------------------------------------------------------------------------------------------------------	---------------------------------------------------------------------------------------------------------------------------------------------------------

## References

-  [TENMARS](#)

[Manuals+](#) [home](#) [privacy](#)